

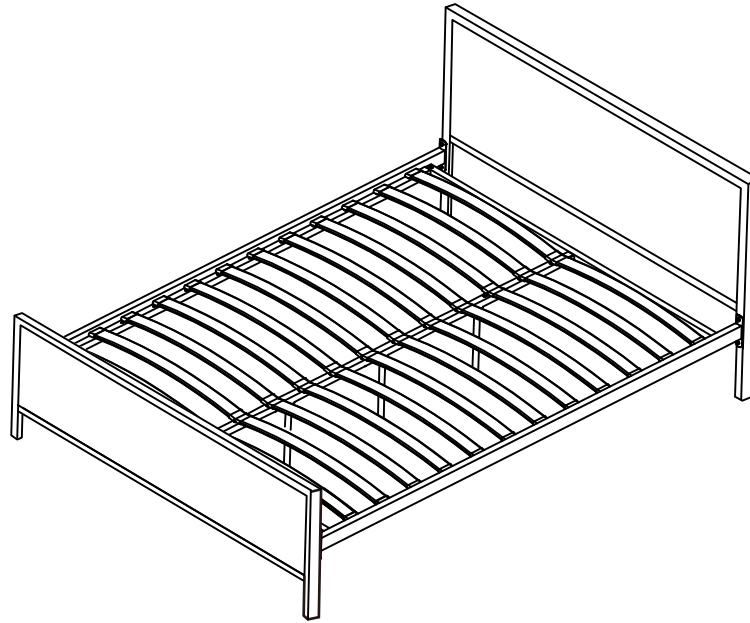









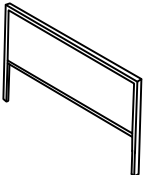

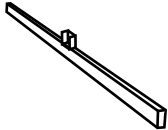
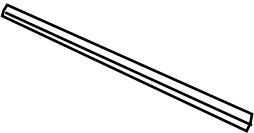
# ASSEMBLY INSTRUCTIONS

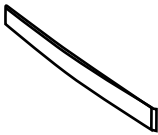
## MODEL: SALISBURY BED (DOUBLE/KING)

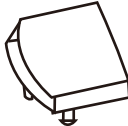
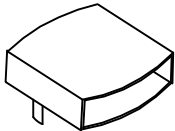

<p>1. Headboard 1 pc</p> 	<p>2. Footboard 1 pc</p> 	<p>3. Siderails 2 pcs</p> 	<p>4. Cross bar 2 pcs</p> 
<p>5. Centre bar 1 pc</p> 	<p>6. Support leg 3 pcs</p> 	<p>7. Slat 24 pcs</p> 	<p>A. M8 x 20mm 8 pcs</p> 
<p>B. M6 x 35mm 9 pcs</p> 	<p>C. Nut 6 pcs</p> 	<p>D. Single plastic cap 24 pcs</p> 	<p>E. Double plastic cap 12 pcs</p> 
<p>F. M4 Allen Key 2 pcs</p> 	<p>G. Spanner 1 pc</p> 		

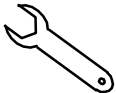
# STEP 1

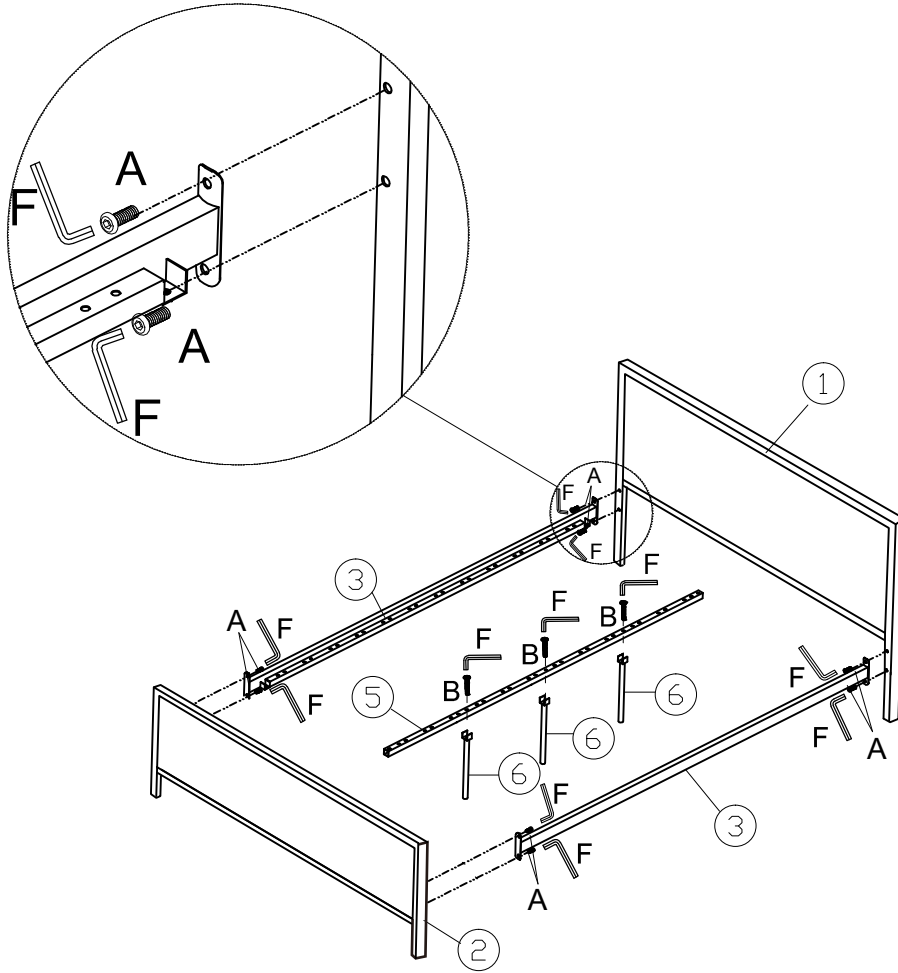

# STEP 2

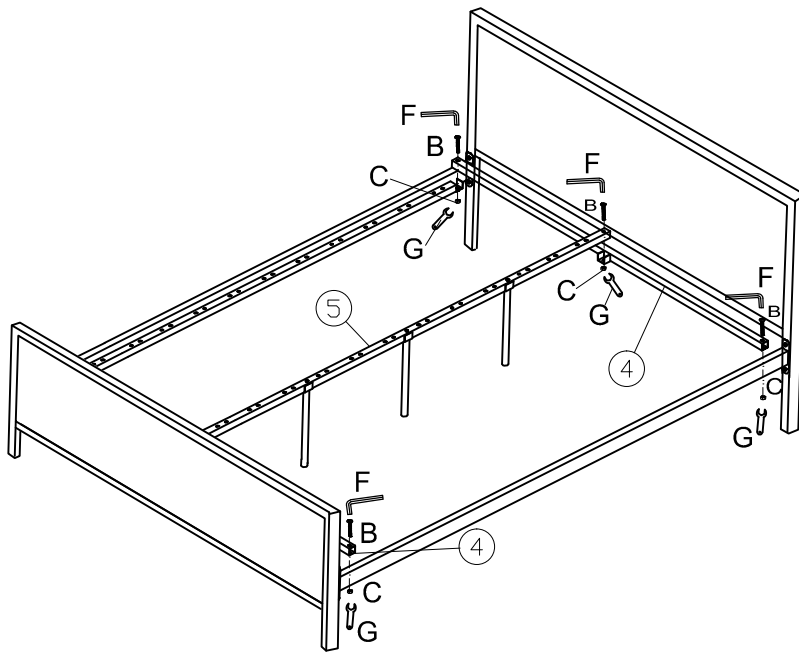

# STEP 3

